

FRESH AIR SURROUND

PURIFIES UP TO 3,000 SQUARE FEET

USER'S MANUAL

CAUTION: Read manual carefully for proper procedures and operation.

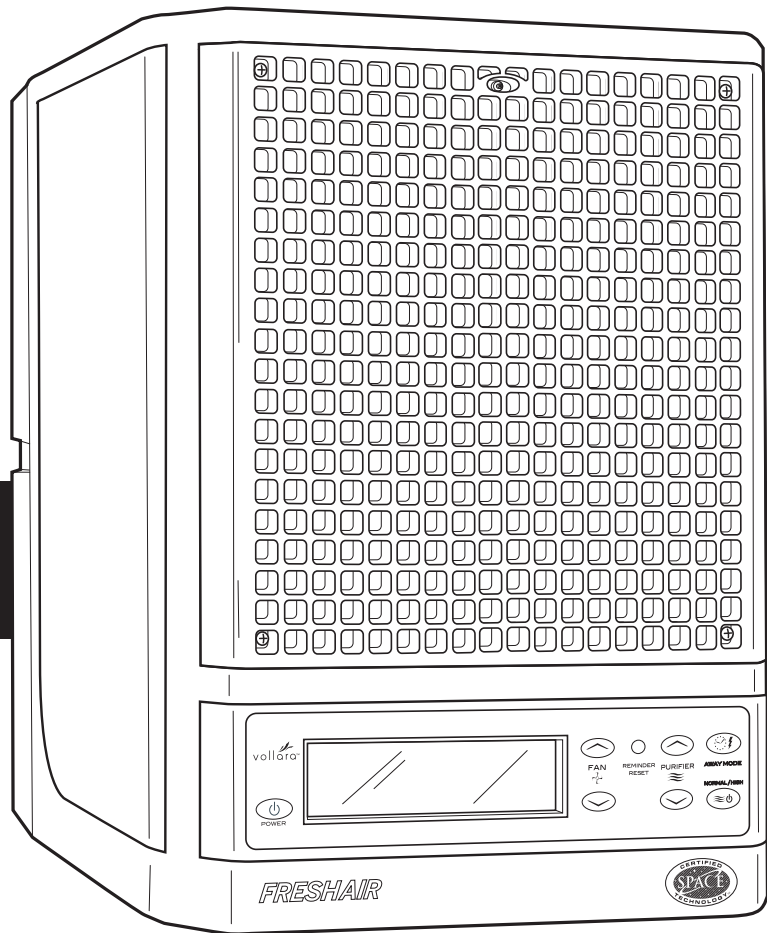

vollar®

CONTENT

Introduction	2
Specifications	2
Your New FreshAir Surround	3
Inspection & Installation	3
Unit Features	3
Operation	4
Placement of Unit	4
Settings & Adjustments	5
LCD Display	5
Maintenance Reminders	6
General Maintenance	6
Optional Pre-filter	7
Removing the Rear Lint Screen	8
Removing the Purifier Plate & ActivePure Cell	8
Installing the ActivePure Cell & Purifier Plate	9
Installing the Rear Lint Screen	9
Troubleshooting	10
Warranty Information	11
FCC Declaration of Conformity	12

INTRODUCTION

Congratulations, you have purchased one of the most effective, technologically advanced air purifiers available. Your new FreshAir Surround is designed to provide years of trouble-free, low maintenance operation. Be sure to read and follow all service procedures outlined in this owner's manual, and use only genuine Vollara replacement parts available from your Vollara Independent Business Owner. If you have any questions concerning this, or any Vollara product, contact Vollara Customer Service or your Vollara Independent Business Owner.

Please record the name and phone number of your Vollara Independent Business Owner:

Name _____

Phone _____

Please record the serial number of your FreshAir Surround:

Serial # _____

SPECIFICATIONS

Electrical:

- 100 ~ 240 VAC 50/60 Hz External Power Supply
- 50 watts maximum power consumption
- Negative ion generation

Size:

- Dimensions:
12" high x 9" wide x 12" deep
- Weight: 10.2 pounds

Purification Plate Output (High Mode):

- > 0.5 ppm

Coverage:

- Covers a range of 250 ft²
(23 m²) to 3000 ft² (279 m²)**

** Depends on variables such as severity and frequency of pollution, humidity, and temperature.

Warranty:

- Three (3) year limited warranty
See page 11 specific details

 **WARNING!** - Do not operate this unit without the rear lint screen AND back cover installed.

 **CAUTION!** - The Away Mode feature of this unit is to be operated in unoccupied areas only.

 **CAUTION!** - Disconnect power cord before servicing.

 **CAUTION!** - Do not operate unit near heat sources, open flame, or combustible vapors or gases.

 **CAUTION:** Do not look directly at the glowing lamp. Prolonged exposure, even to reflected UV light, can cause eye damage according to the American Conference of Governmental Industrial Hygienists (ACGIH) Standards.

 **CAUTION!** - Allow your FreshAir Surround to warm to room temperature before operating. Damage may result from turning on a cold unit.

YOUR NEW FRESHAIR SURROUND

- Eliminates smoke, odors, and tobacco smoke
- Includes our exclusive ActivePure® Technology
- High-intensity UVC lamp
- Removes odors from your home, office, car boat, RV, etc
- Improves the quality of air indoors, up to 3000 ft² (279 m²)
- Customizable to your environment, using either the included remote or the controls on the front of the unit
- Maintenance Reminders alert you when normal maintenance needs to be performed or service is required

INSPECTION & INSTALLATION

1. Remove protective packaging
2. Remove unit from shipping carton
3. Remove all protective materials
4. Check for shipping damage and loose or broken parts
5. Read Owner's Manual thoroughly prior to installation
6. Install batteries in remote
7. Determine placement location for the unit (See "Placement of Unit" on page 4)
8. Insert the power supply plug into the power receptacle on the rear of the unit. Plug the appropriate cord into the power supply and into a working electrical outlet
9. Using either the remote control or the Power button, turn the unit ON

UNIT FEATURES

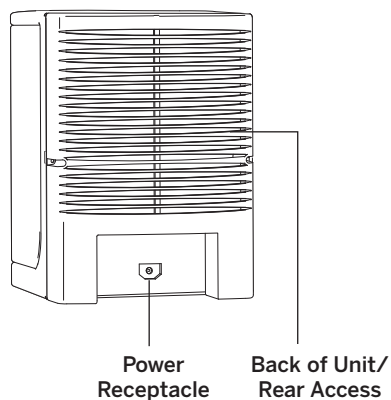
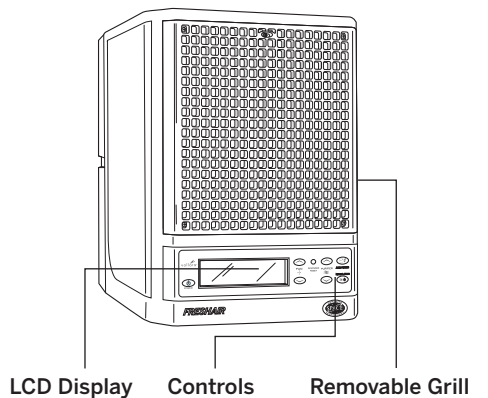

- Exclusive ActivePure® Technology
- Needlepoint and RF Ion Generation
- Five Speed Fan
- Adjustable Purifier Control (High Mode only)
- LCD Display
- Away Mode Function w/Adjustable Digital Timer
- Maintenance Reminders
- Remote Control or Manual Operation
- Washable Purification Plate
- Washable Rear Lint Screen
- Replaceable ActivePure Cell
- Removable Front Grill
- Universal Power Supply with two (2) cords

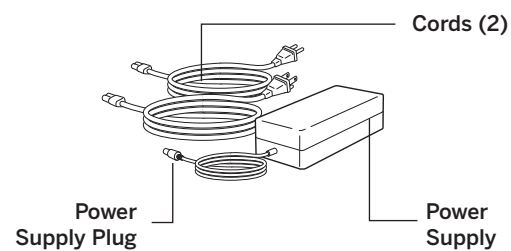

OPERATION

1. Adjust the fan speed to your preference, keeping in mind that higher fan speeds will give better results
2. Using the *Normal/High* button, set the unit to NORMAL, for typical use, or HIGH, for increased smoke and odor control
3. For HIGH MODE, using the *Purifier Up* and *Purifier Down* buttons, adjust the purification level to its lowest setting (250ft² (23 m²)) for the first 24 hours of operation, then gradually adjust up (if needed) to the square footage (or square meters) of the indoor area

If you are operating your central heating and air conditioning fan or other ventilation system continuously, set the coverage up to the total ventilated indoor area. Otherwise, set the coverage up to the size of the room. Do not exceed the size of the ventilated indoor area when setting the purifier level.

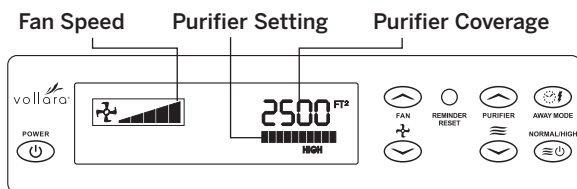

HIGH MODE: The unit's display shows the fan speed (low to high), the purifier setting (1 bar to 12 bars), and the purifier coverage in square feet, for U.S. models, and square meters, for international units.

4. To operate the AWAY MODE feature, **in unoccupied areas only,*** press the *Away Mode* button until the desired time is reached (2, 4, 6, or 8 hours). The unit will display AWAY MODE and the remaining time. To interrupt the AWAY MODE, press the *Normal/High* button

***Please note: "unoccupied areas" includes pets. Some pets, like humans, may experience adverse reactions from exposure to increased levels of ozone and should not be present during AWAY MODE operation.**

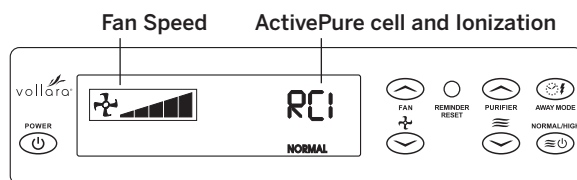

NORMAL MODE: The unit's display shows the fan speed (low to high) and NORMAL to indicate that the ActivePure cell and ionization are both functioning normally.

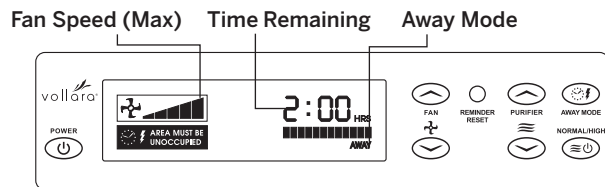

AWAY MODE: The fan will show maximum, and AWAY MODE will replace the purifier setting. The amount of time remaining will depend on how long you have selected for the AWAY MODE function to operate. The colon (:) will flash to indicate time being counted down.

PLACEMENT OF UNIT

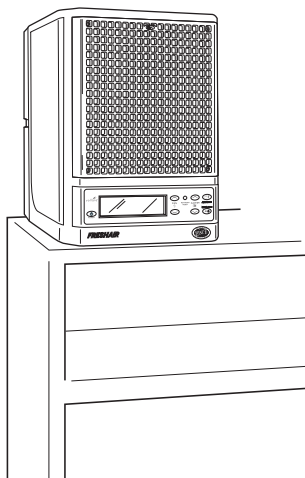

Place the unit as high as possible to ensure complete purification. (On top of a bookshelf, high cabinet, etc.)

Suggested locations listed in the order of preference:

1. Nearest the source of the worst pollution
2. Near a cold-air return to thoroughly circulate the benefits of your FreshAir Surround throughout the area
3. In the area most heavily used to achieve maximum benefit







Note:

- The rear of the unit should always have at least one inch of open area to allow unrestricted airflow
- Point the unit toward the center of the room for maximum dispersion of ions
- To prevent injury, be sure the power cord is not accessible to small children

SETTINGS AND ADJUSTMENTS

FreshAir Surround can be turned on or off, and adjusted, using either the included remote or the control panel on the front of the unit. With the exception of the *Reminder Reset* button, both the remote and the control panel buttons have the same functions.

If you are operating your central heating and air conditioning fan or other ventilation system continuously, set the coverage up to the total ventilated indoor area. Otherwise, set the coverage up to the size of the room. Do not exceed the size of the ventilated indoor area when setting the purifier level.

-  **POWER (stand by)**
Turns the unit ON and OFF.
-  **FAN UP/FAN DOWN**
Adjusts the five speed fan.
-  **PURIFIER UP/PURIFIER DOWN (High Mode only)**
Works when unit is in High Mode to set the purifier level for the indoor area.
The level is indicated by both a horizontal bar graph and square footage (U.S. models) or square meters (international models). The unit will switch to Normal Mode, if the Purifier DOWN button is pressed when the square footage is set to 250 ft² (23 m²).
-  **NORMAL/HIGH**
Toggles the unit between Normal Mode (ActivePure and Ionization) and High Mode (ActivePure, Ionization, and Purification Plate).
-  **AWAY MODE**
Turns on and adjusts the timer for the Away Mode function. Each press of the Away Mode button will increase the time by two hours, up to eight hours, then off. The Away Mode should be operated in unoccupied areas only.*
-  **REMINDER RESET (control panel only)**
Clears the maintenance reminders after performing routine maintenance.
-  **DISPLAY FT² / M² (remote control only)**
Changes the purifier coverage shown on the LCD screen from square feet to square meters

**Please note: "unoccupied areas" includes pets. Some pets, like humans, may experience adverse reactions from exposure to increased levels of ozone and should not be present during Away Mode operation.*

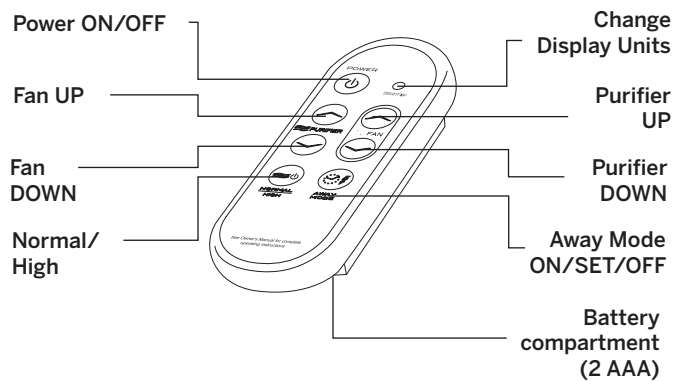
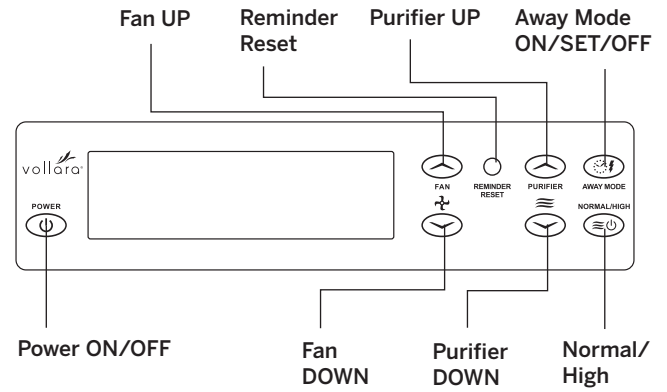

LCD DISPLAY

The LCD Screen is used to display all current settings (see page 4) as well as any maintenance reminders.

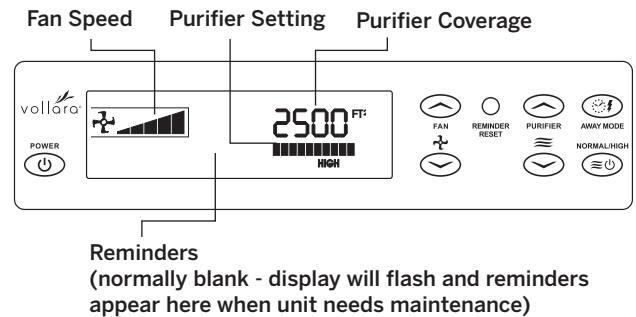

LCD SCREEN BACKLIGHT

As adjustments are being made, the LCD screen backlight will brighten and the settings on the screen will change. After 3 seconds, without change, the backlight will return to normal.

If a maintenance reminder or a service reminder appears, the backlight will brighten and constantly flash until the Reminder Reset button is pressed or the service problem is corrected.

MAINTENANCE REMINDERS

When maintenance is required, display screen will brighten and flash and the maintenance reminder will appear.



REPLACE PLATE

The purifier plate is not functioning properly.

- Replace the old purifier plate with a new purifier plate (available from your local Vollara Independent Business Owner)



REPLACE RCI CELL

The ActivePure cell is no longer working correctly

- Replace the ActivePure cell (replacement cells are available from your local Vollara Independent Business Owner).
- *Please Note: The ActivePure cell should be replaced every two (2) years, even if the unit does not display this message*



PERFORM CLEANING

(approx. every 30 days)

- Clean the rear lint screen (see page 6)
- Vacuum the ActivePure cell
- Clean the purifier plate (see page 7)
- Vacuum front and rear grill openings

Be sure to press the Reminder Reset button to clear the reminder following regular maintenance (see below).

RESETTING THE REMINDERS

The only reminder you need to reset is the PERFORM CLEANING reminder (after performing maintenance, press the Reminder Reset button and the screen will momentarily display CLEARED to let you know the reminder has been cleared). All the other service reminders will clear automatically once the unit has been turned off and back on and the problem has been corrected.

GENERAL MAINTENANCE

CAUTION: Unplug the unit before performing any maintenance procedures.

Periodic maintenance is required to ensure that your FreshAir Surround operates properly. The unit will display a PERFORM CLEANING reminder when it's time to

GENERAL MAINTENANCE (CONT.)

perform regular maintenance. If you are operating your unit in a severely polluted environment, cleaning of the unit, purifier plate, ActivePure cell, and rear lint screen should be done more frequently. Shown here are basic procedures that should be carried out to keep your unit running at top performance.

For optimal performance, and to prevent damage not covered by your warranty, install the Optional Pre-filter (see page 7).

Failure to perform routine maintenance could adversely affect the proper function of the unit or cause it to fail prematurely.

NOTE: If a unit is returned for repair, and it is determined that neglect of the unit or unauthorized tampering with any mechanical or electronic component of the unit caused the failure, Vollara reserves the right to void the product warranty. This will require the owner to pay for any required repairs.

CLEANING THE CASE:

Wipe the unit with a soft cloth dampened (not wet) with water. Do not use chemicals or solvents. Vacuum the front and rear grills periodically to remove any lint buildup.

CLEANING THE ACTIVEPURE CELL:

Remove the ActivePure cell and carefully vacuum accumulated lint. Do not wash the ActivePure cell. Damage from water may result.

REAR LINT SCREEN CLEANING:

You have two options to clean the rear lint screen:

1. When visibly dirty, simply remove the rear lint screen from the unit (see pages 8 - 9), and with a hand-held vacuum, remove the heavy particulate. This method will extend the life of the lint screen.
2. When visibly dirty, remove the lint screen from the unit (see pages 8 - 9), carefully vacuum, then wash in hot water (do not use soap). Allow to dry prior to reinstalling. Replace if damaged.

REAR LINT SCREEN REPLACEMENT:

Contact your Vollara Independent Business Owner for replacement lint screens. See pages 8 - 9 for removal and installation instructions.

GENERAL MAINTENANCE (CONT.)

CAUTION: Unplug unit before performing any maintenance procedures.

CLEANING THE PURIFIER PLATE:

Remove the rear lint screen (see pages 8 - 9). Carefully remove the purifier plate from the card cage by grasping the middle of the edge nearest to you, and slowly pull it straight out.

If you are in an environment where there are fats, oils, or grease, such as in a kitchen, start by cleaning with denatured alcohol and a soft bristle brush. This will cut the grease without leaving a residue.

For all applications - Clean with a mixture of one part water and one part ammonia to remove contaminants. Place the plate into a shallow dish, and pour enough of the water/ammonia solution into the dish to just cover plate. Allow the plate to soak for no more than 10 minutes.

CAUTION: Damage may result from soaking the purifier plate longer than 10 minutes.

Remove plate and scrub with a soft bristle brush. Rinse thoroughly. **Let air-dry for 24 hours or use a blow dryer to dry thoroughly.**

The unit will display a REPLACE PLATE message if the purification plate needs to be replaced.

CHANGING THE ACTIVEPURE CELL:

The ActivePure cell should be changed when REPLACE RCI CELL appears on the display, or **twelve (12) months when used continuously or two (2) years if used less than 12 hours a day**, whichever comes first. To change the ActivePure cell, follow the instructions on pages 8 - 9.

SEE PAGES 8 - 9 FOR REMOVAL AND INSTALLATION INSTRUCTIONS

** See next page for back cover removal instructions*

OPTIONAL PRE-FILTER

To Remove:

Rear Back Panel
follow steps 1 - 3,
pg. 8

Pre-filter
follow steps 4 - 5
pg. 8

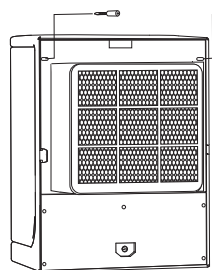

1. Remove the two (2) thumbscrews securing the top of the lint screen.

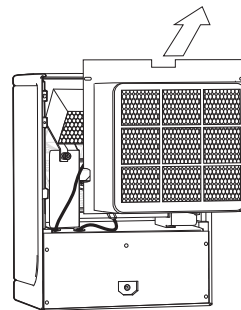

2. Remove the lint screen by pulling back the top, then lifting up and out.

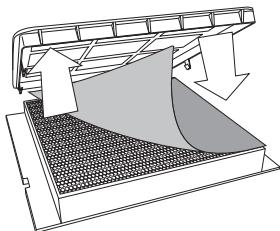

3. (a) For first install, lay Optional Pre-filter on filter.
(b) For replacing, remove Optional Pre-filter and replace with a new one.

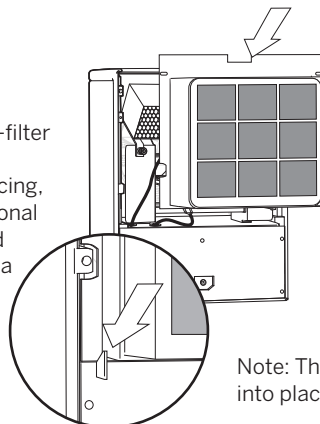

4. Replace the rear lint screen, inserting the bottom of the lint screen first.

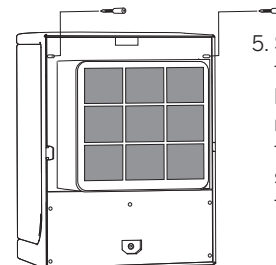

5. Secure the top of the lint screen by replacing the two (2) lint screen holder thumbscrews.

Note: The bottom of the rear lint screen is held into place by two alignment guides (see inset).

REMOVING THE REAR LINT SCREEN

CAUTION: Unplug unit before performing any maintenance procedures.

To Remove:

Rear Lint Screen
follow steps 1 - 5

Purifier Plate
follow steps 1 - 6

ActivePure cell
follow steps 1 - 10

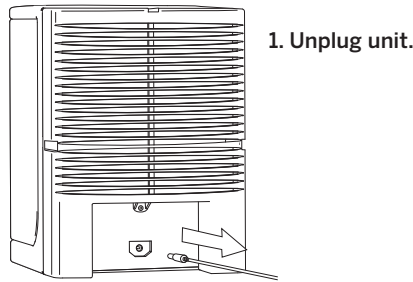

1. Unplug unit.

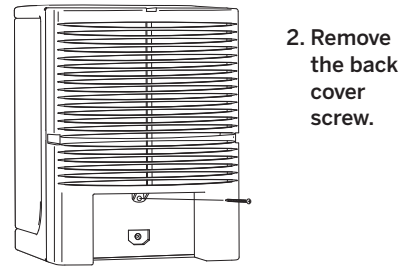

2. Remove the back cover screw.

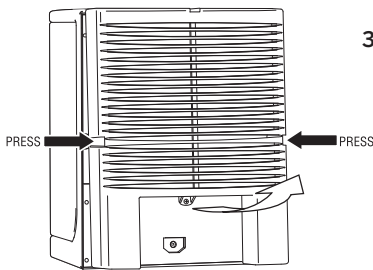

3. Remove back cover. Press the sides to unlatch, then tilt the bottom out to remove.

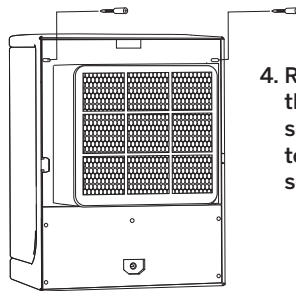

4. Remove two thumbscrews securing the top of the lint screen.

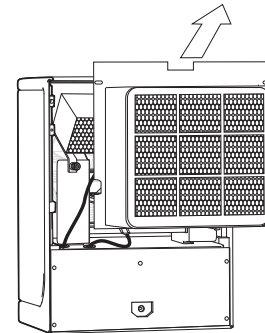

5. Remove the lint screen by pulling back the top, then lifting up and out.

REMOVING THE PURIFIER PLATE & ACTIVEPURE CELL

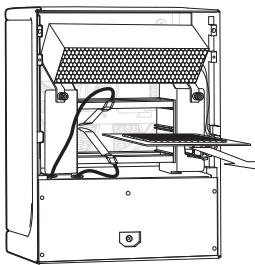

6. To remove the purification plate, grasp edge of plate in the center and gently pull out.

NOTE: If the plate is difficult to remove, gently press down on the lower metal contact tab.

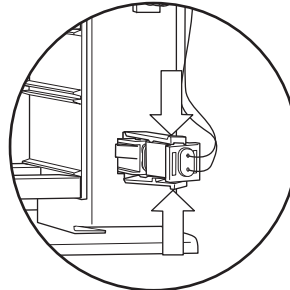

7. Unlock the ActivePure cell connector by pressing on the connector's locking tabs.

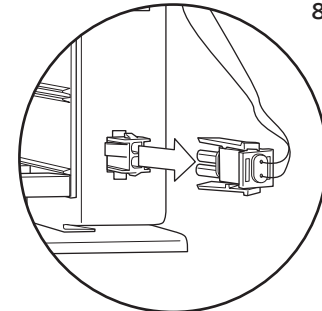

8. Pull the connector straight out to unplug.

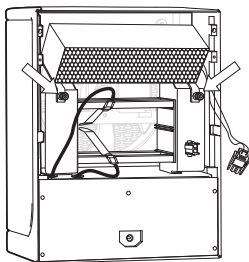

9. Remove two (2) thumbscrews.

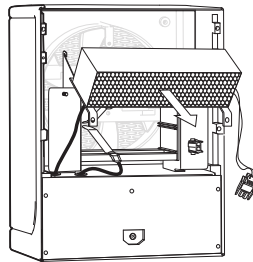

10. Slide the ActivePure cell down and out of unit.

WARNING: Do not operate FreshAir Surround without the rear lint screen and back cover properly installed.

NOTE: Use genuine Vollara replacement parts only. Parts from anyone other than Vollara may damage your unit and void your warranty.

INSTALLING THE ACTIVEPURE CELL & PURIFIER PLATE

CAUTION: Unplug unit before performing any maintenance procedures.

To Install:

Rear Lint Screen follow steps 5 - 9

Purifier Plate follow steps 4 - 9

ActivePure cell follow steps 1 - 9

When installing the purification plate, be sure the metal tabs are making contact with the screen on each side of the plate.

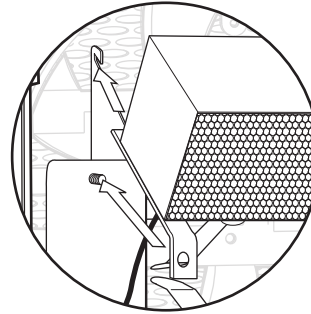
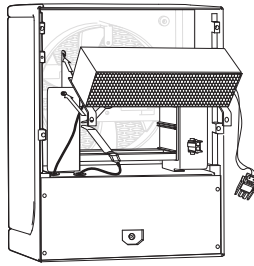

1. Slide the ActivePure cell up and into the unit. Be sure the back lip of the ActivePure cell engages the two slotted protrusions at the rear of the plate cage, and that the angle brackets and studs are correctly aligned.

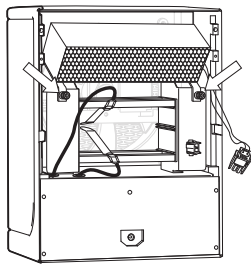

2. Replace the two (2) thumbscrews and tighten.

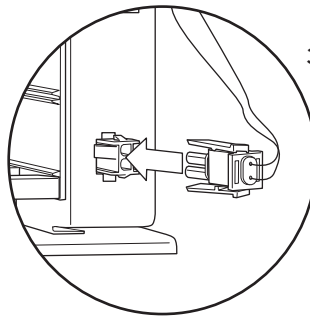

3. Insert the ActivePure cell connector into the plug on the plate cage. Press the connector firmly until the two tabs lock into place.

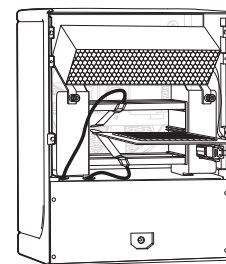

4. Gently insert the purifier plate between the guides (inside the cage) until it stops.

INSTALLING THE REAR LINT SCREEN

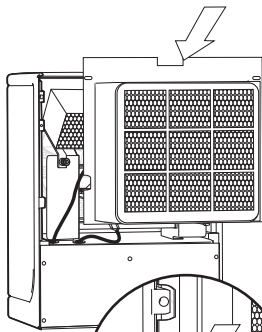

5. Replace the rear lint screen, inserting the bottom of the lint screen first.

Note: The bottom of the rear lint screen is held into place by two alignment guides (see inset).

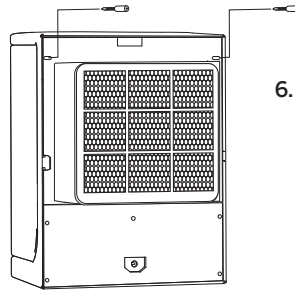
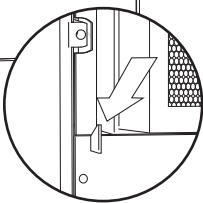

6. Secure the top of the lint screen by replacing the two (2) lint screen holder thumbscrews.

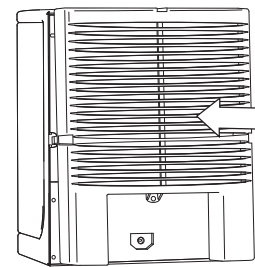

7. Replace the back cover by snapping into place

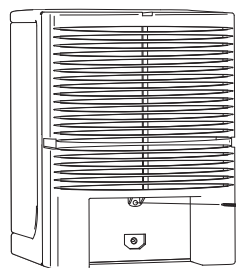

8. Replace the back cover screw.

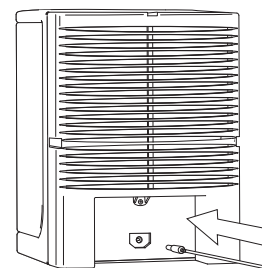

9. Reinstall the power cord.

WARNING: Do not operate FreshAir Surround without the rear lint screen and back cover properly installed.

For disassembly instructions, see page 8.

TROUBLESHOOTING

INDICATORS OF OPERATION:

When the unit is on, the LCD display will show either the fan setting and NORMAL, or the fan setting, purifier setting, and square footage. If the unit is in Away Mode, it will display AWAY MODE plus the hours and minutes remaining. See page 4 for more information.

TROUBLESHOOTING - WHAT TO LOOK FOR FIRST.

1. *I have plugged in the unit, pressed the ON button on the remote (or the unit), and nothing happens... what's wrong?*

- Make sure the power cord is inserted completely into the receptacle on the back of the unit.
- Make sure the electrical outlet is capable of providing power to the unit.

If you are operating your central heating and air conditioning fan, or other ventilation system continuously, set the coverage up to the total ventilated indoor area. Otherwise, set the coverage up to the size of the room. Do not exceed the size of the ventilated indoor area when setting the purifier level.

Please note: The AWAY MODE should be operated in unoccupied areas only. "Unoccupied areas" includes pets. Some pets, like humans, may experience adverse reactions from exposure to increased levels of ozone and should not be present during Away Mode operation.

2. *The fan is operating but the purifier plate is not working... what's wrong?*

- The unit is in Normal Mode (press the Normal/High switch to change to High Mode).
- If the unit is displaying a REPLACE PLATE message, check the purifier plate for serviceability. If it is cracked or broken, the purifier plate will require replacement. Ensure maintenance procedures required for the purifier plate have been performed according to the "Maintenance" section of this Owner's Manual. Order

new purifier plates from your Vollara Business Owner.

- The electrical stainless steel contacts are not contacting the screen portion of the purifier plate. Unplug and inspect the unit for any loose connections.
 - Do not attempt to disassemble the unit. This will void the warranty of the product.
3. *The purifier plate is making a noise, has a burning smell, and/or appears to arc or spark. What is the problem?*
- The purifier plate is most likely cracked. The unit will display a REPLACE PLATE message. Refer to the answers for question # 2, as it would apply to this question also.
4. *The UV lamp is not functioning/I'm getting a "Replace RCI Cell" message.*
- Check ActivePure cell for proper installation.
 - Replace the ActivePure cell.

CAUTION: Do not look directly at the glowing lamp. Prolonged exposure, even to reflected UV light, can cause eye damage according to the American Conference of Governmental Industrial Hygienists (ACGIH) Standards.

5. *What are the most typical application problems?*

- Symptom: A belief that the proper equipment is placed in the environment and the equipment appears unsuccessful.
Problem: Lack of air movement, improper placement of the unit.
- Symptom: Strong odors still remain within the environment after placement.
Problem: Purifier setting is too low, improper placement of the unit, or the source of the odor has not been eliminated.
- Symptom: A strong odor of ozone is present within the environment.
Problem: Too much ozone accumulation within the environment as a result of improper purifier control setting, and/or lack of air movement.

TROUBLESHOOTING

- Symptom: Visual haze of smoke and/or particulate remain within the environment.

Problem: Lack of ionization and/or air movement.

6. Air flow is restricted or reduced.

- Is the unit properly placed away from objects that may obstruct air flow?
- Are the rear lint screen, back cover, and front grill clean?
- Is the ActivePure cell clean?

7. How can I tell if the ActivePure cell is functioning?

- The ActivePure cell will produce a glow that is visible

through the front grill under low light conditions.

8. Unit does not operate.

- Is the unit plugged in?
- Are you sure the outlet is active?
- Are the rear lint screen and back cover installed properly?

WARRANTY INFORMATION

LIMITED 3 YEAR WARRANTY

WHAT IS COVERED BY THIS WARRANTY

We warrant the FreshAir Surround (excluding filters and purification plates) to the consumer, subject to the conditions below, against defects in workmanship or material, provided that the products are returned to a service location within the following time periods:

- FreshAir Surround within three (3) years of date of purchase.
- ActivePure® Cell within ninety (90) days of date of purchase

INSTALLATION AND MAINTENANCE REQUIREMENTS

This warranty is expressly conditioned upon proper installation, operation, cleaning and maintenance, all in accordance with the Owner's Manual. Failure to meet any of these requirements will void this warranty. Servicing of your FreshAir Surround by parties other than our authorized representative and/or using parts other than genuine parts will also void this warranty.

HOW TO OBTAIN WARRANTY SERVICE

Customer must contact Vollara Customer Service or their Independent Business Owner and provide proof of purchase within the above time period. We will repair or replace and return the product, without charge and within a reasonable period of time, subject to the conditions in the above paragraphs, if its examination shall disclose any part to be defective in workmanship or material. If we, in our discretion, are unable to repair the product after a reasonable number of attempts, we will provide either a refund of the purchase price or a replacement unit, at the company's option.

WHAT IS NOT COVERED BY THIS WARRANTY

This product is intended for household use only. Ordinary wear and tear shall not be considered a defect in workmanship or material. These warranties do not apply to filters nor for loss or

damage caused by accident, fire, abuse, misuse, improper installation, modification, misapplication, commercial use, or by any repairs other than those provided by our authorized Service Center.

MISSING SERIAL NUMBERS AND UNAUTHORIZED CHANNELS

If a valid serial number is missing from the product, the warranty will be voided. Vollara products are authorized for sale through Vollara Independent Business Owners only. Warranties are voided if a product is purchased through unauthorized channels, this includes websites that are not authorized to use Vollara's trademarked names, images and logos as well as Internet auction sites (e.g. ebay and Craigslist). The only approved Internet presence for Vollara products is www.vollara.com. To confirm warranty coverage prior to purchasing a product, contact Vollara at 800.989.2299 with the serial number located on the back of the unit.

EXCLUSION OF OTHER WARRANTIES AND CONDITIONS

EXCEPT AS PROVIDED HEREIN, WE MAKE NO REPRESENTATION OR WARRANTY OF ANY KIND. ALL OTHER WARRANTIES OF ANY KIND, EXPRESS OR IMPLIED, ARE HEREBY EXPRESSLY DISCLAIMED, INCLUDING ANY IMPLIED WARRANTY OF MERCHANTABILITY OR FITNESS FOR A PARTICULAR PURPOSE.

LIMITATION OF LIABILITY FOR SPECIAL, INCIDENTAL, OR CONSEQUENTIAL DAMAGES

WE SHALL NOT IN ANY CASE BE LIABLE FOR SPECIAL, INCIDENTAL OR CONSEQUENTIAL DAMAGES ARISING FROM BREACH OF EXPRESSED OR IMPLIED WARRANTIES, CONDITIONS, GUARANTEES OR REPRESENTATIONS, BREACH OF CONTRACT, NEGLIGENCE OR ANY OTHER LEGAL THEORY. Such excluded damages include, but are not limited to, loss of profits or revenue, and loss of the use of the products.

FOR U.S. APPLICATION ONLY

This warranty gives you specific legal rights, and you may also have other rights which vary from state to state. Some states do not allow limitations on warranties, or on remedies for breach. In such states, the above limitations may not apply to you.

FOR CANADIAN APPLICATION ONLY

Exclusion of Subsequent Owners: Except as otherwise required by applicable legislation, this warranty is not transferable. This warranty gives you specific legal rights and you may also have other rights which vary from province to province. Some provinces and territories do not allow limitations on warranties, or on remedies for breach. In such provinces or territories, the above limitations may not apply to you. If any provision of this warranty or part thereof is held by a court of competent jurisdiction to be invalid, illegal, or unenforceable, the validity, legality and enforceability of the remaining provisions or parts thereof will not in any way be affected or impaired within the jurisdiction of that court. This entire warranty shall continue to be valid, legal and enforceable in any jurisdiction where a similar determination has not been made.

This warranty is provided by
Vollara, LLC
5420 LBJ Freeway, Suite 1010
Dallas, TX 75240.

SERVICE

Every effort is made to ensure customers receive an up-to-date instructions manual on the use of our products; however, from time to time, modifications to our products may without notice make the information contained herein subject to alteration. For the latest information, please visit our web site.

FCC DECLARATION OF CONFORMITY

Name: Vollara, LLC
Model: FreshAir Surround

This device complies with Part 18 of the FCC Rules.

RESPONSIBLE PARTY

Vollara, LLC
5420 LBJ Freeway, Suite 1010
Dallas, TX 75240
Ph: (800) 989-2299

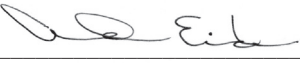
Signature: 

Printed Name: Andy Eide

Title: Vice President, Product Development & Research

Date: 06/14/2012

This equipment has been tested and found to comply with the limits for Industrial, Scientific, and Medical Equipment (ISM), pursuant to Part 18 of the FCC Rules. These limits are designed to provide reasonable protection against harmful interference in a residential installation. This equipment generates, uses, and can radiate radio frequency energy, and if not installed and used in accordance with the instructions, may cause harmful interference to radio communications. However, there is no guarantee that interference will not occur in a particular installation. If this equipment does cause harmful interference to radio or television, which can be determined by turning the equipment off and on, the user is encouraged to try to correct the interference by one or more of the following measures:

Reorient or relocate the receiving antenna.

Increase the separation between the equipment and receiver.

Connect the equipment into an outlet on a circuit different from that to which the receiver is connected.

Consult the Business Owner or an experienced radio/TV technician for help.

CE DECLARATION OF CONFORMITY



Name: Vollara, LLC
Model: FreshAir Surround
Vollara, LLC
5420 LBJ Freeway, Suite 1010
Dallas, TX 75240
Ph: (800) 989-2299

We, on behalf of: Vollara, LLC
5420 LBJ Freeway, Suite 1010
Dallas, TX 75240
U.S.A.

Declare under our sole responsibility, that the Electronic Air Purification System

Model: FreshAir Surround

to which this declaration relates, conforms with the following standards:

EN55014-1	EMC Requirements for Household Appliances and Similar Apparatus - Emissions
EN50014-2	EMC Requirements for Household Appliances and Similar Apparatus - Immunity
EN60335-1: 2002	Safety of Household and Similar Electrical Appliances - General Requirements
EN60335-2-65:2003	Safety of Household and Similar Electrical Appliances - Air Cleaning Appliances

By conformance with the standard referenced, the product meets the provisions of the EU Directives listed below:

Low Voltage Directive	2006/95/EC
EMC Directive	89/336/EEC as amended by 92/31/EEC and 93/68/EEC
RoHS Directive	2002/95/EC
WEEE Directive	2002/96/EC

Authorized by:

Representative: Andy Eide
Title: Vice President, Product Development and Research
Company: Vollara, LLC
5420 LBJ Freeway, Suite 1010
Dallas, TX 75240
U.S.A.
Date: 06/14/2012

